

USER MANUAL

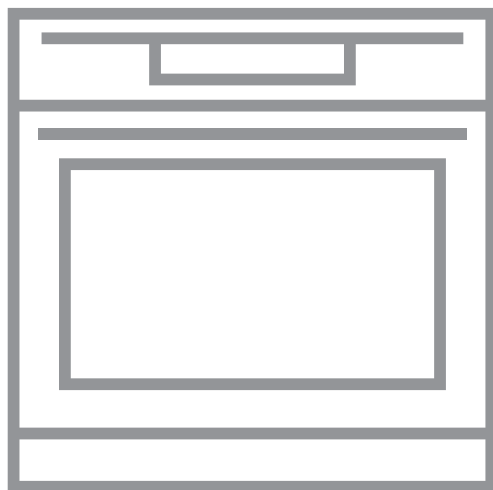

CONTENTS

1. SAFETY INFORMATION.....	2
2. SAFETY INSTRUCTIONS.....	4
3. PRODUCT DESCRIPTION.....	7
4. OPERATING THE APPLIANCE.....	8
5. BEFORE FIRST USE.....	9
6. DAILY USE.....	10
7. CLOCK FUNCTIONS.....	21
8. USING THE ACCESSORIES.....	21
9. ADDITIONAL FUNCTIONS.....	24
10. HINTS AND TIPS.....	24
11. CARE AND CLEANING.....	47
12. TROUBLESHOOTING.....	51
13. ENERGY EFFICIENCY.....	54

FOR PERFECT RESULTS

Thank you for choosing this AEG product. We have created it to give you impeccable performance for many years, with innovative technologies that help make life simpler features you might not find on ordinary appliances. Please spend a few minutes reading to get the very best from it.

Visit our website for:



Get usage advice, brochures, trouble shooter, service information:

www.aeg.com/webselfservice



Register your product for better service:

www.registeraeg.com



Buy Accessories, Consumables and Original spare parts for your appliance:

www.aeg.com/shop

CUSTOMER CARE AND SERVICE

Always use original spare parts.

When contacting our Authorised Service Centre, ensure that you have the following data available: Model, PNC, Serial Number.

The information can be found on the rating plate.

 Warning / Caution-Safety information

 General information and tips

 Environmental information

Subject to change without notice.

1. SAFETY INFORMATION

Before the installation and use of the appliance, carefully read the supplied instructions. The

manufacturer is not responsible for any injuries or damages that are the result of incorrect installation or usage. Always keep the instructions in a safe and accessible location for future reference.

1.1 Children and vulnerable people safety

- This appliance can be used by children aged from 8 years and above and persons with reduced physical, sensory or mental capabilities or lack of experience and knowledge if they have been given supervision or instruction concerning the use of the appliance in a safe way and understand the hazards involved.
- Children between 3 and 8 years of age and persons with very extensive and complex disabilities shall be kept away unless continuously supervised.
- Children of less than 3 years of age should be kept away unless continuously supervised.
- Do not let children play with the appliance.
- Keep all packaging away from children and dispose of it appropriately.
- Keep children and pets away from the appliance when it operates or when it cools down. Accessible parts are hot.
- If the appliance has a child safety device, it should be activated.
- Children shall not carry out cleaning and user maintenance of the appliance without supervision.

1.2 General Safety

- Only a qualified person must install this appliance and replace the cable.
- **WARNING:** The appliance and its accessible parts become hot during use. Care should be taken to avoid touching heating elements.
- Always use oven gloves to remove or put in accessories or ovenware.
- Before carrying out any maintenance, disconnect the appliance from the power supply.

- Ensure that the appliance is switched off before replacing the lamp to avoid the possibility of electric shock.
- Do not use a steam cleaner to clean the appliance.
- Do not use harsh abrasive cleaners or sharp metal scrapers to clean the glass door since they can scratch the surface, which may result in shattering of the glass.
- If the mains power supply cable is damaged, it must be replaced by the manufacturer, its Authorised Service Centre or similarly qualified persons to avoid an electrical hazard.
- To remove the shelf supports first pull the front of the shelf support and then the rear end away from the side walls. Install the shelf supports in the opposite sequence.
- Use only the food sensor (core temperature sensor) recommended for this appliance.

2. SAFETY INSTRUCTIONS

2.1 Installation



WARNING!

Only a qualified person must install this appliance.

- Remove all the packaging.
- Do not install or use a damaged appliance.
- Follow the installation instructions supplied with the appliance.
- Always take care when moving the appliance as it is heavy. Always use safety gloves and enclosed footwear.
- Do not pull the appliance by the handle.
- Keep the minimum distance from other appliances and units.
- Make sure that the appliance is installed below and adjacent safe structures.
- The sides of the appliance must stay adjacent to appliances or units with the same height.
- The appliance is equipped with an electric cooling system. It must be operated with the electric power supply.

2.2 Electrical connection



WARNING!

Risk of fire and electric shock.

- All electrical connections should be made by a qualified electrician.
- The appliance must be earthed.
- Make sure that the parameters on the rating plate are compatible with the electrical ratings of the mains power supply.
- Always use a correctly installed shockproof socket.
- Do not use multi-plug adapters and extension cables.
- Make sure not to cause damage to the mains plug and to the mains cable. Should the mains cable need to be replaced, this must be carried out by our Authorised Service Centre.
- Do not let mains cables touch or come near the appliance door, especially when the door is hot.
- The shock protection of live and insulated parts must be fastened in

such a way that it cannot be removed without tools.

- Connect the mains plug to the mains socket only at the end of the installation. Make sure that there is access to the mains plug after the installation.
- If the mains socket is loose, do not connect the mains plug.
- Do not pull the mains cable to disconnect the appliance. Always pull the mains plug.
- Use only correct isolation devices: line protecting cut-outs, fuses (screw type fuses removed from the holder), earth leakage trips and contactors.
- The electrical installation must have an isolation device which lets you disconnect the appliance from the mains at all poles. The isolation device must have a contact opening width of minimum 3 mm.
- This appliance complies with the E.E.C. Directives.

2.3 Use



WARNING!

Risk of injury, burns and electric shock or explosion.

- This appliance is for household use only.
- Do not change the specification of this appliance.
- Make sure that the ventilation openings are not blocked.
- Do not let the appliance stay unattended during operation.
- Deactivate the appliance after each use.
- Be careful when you open the appliance door while the appliance is in operation. Hot air can release.
- Do not operate the appliance with wet hands or when it has contact with water.
- Do not apply pressure on the open door.
- Do not use the appliance as a work surface or as a storage surface.
- Open the appliance door carefully. The use of ingredients with alcohol can cause a mixture of alcohol and air.

- Do not let sparks or open flames to come in contact with the appliance when you open the door.
- Do not put flammable products or items that are wet with flammable products in, near or on the appliance.



WARNING!

Risk of damage to the appliance.

- To prevent damage or discoloration to the enamel:
 - do not put ovenware or other objects in the appliance directly on the bottom.
 - do not put aluminium foil directly on the bottom of cavity of the appliance.
 - do not put water directly into the hot appliance.
 - do not keep moist dishes and food in the appliance after you finish the cooking.
 - be careful when you remove or install the accessories.
- Discoloration of the enamel or stainless steel has no effect on the performance of the appliance.
- Use a deep pan for moist cakes. Fruit juices cause stains that can be permanent.
- This appliance is for cooking purposes only. It must not be used for other purposes, for example room heating.
- Always cook with the oven door closed.
- If the appliance is installed behind a furniture panel (e.g. a door) make sure the door is never closed when the appliance is in operation. Heat and moisture can build up behind a closed furniture panel and cause subsequent damage to the appliance, the housing unit or the floor. Do not close the furniture panel until the appliance has cooled down completely after use.

2.4 Steam Cooking



WARNING!

Risk of burns and damage to the appliance.

- Released Steam can cause burns:

- Be careful when you open the appliance door when the function is activated. Steam can release.
- Open the appliance door with care after the steam cooking operation.

2.5 Care and cleaning



WARNING!

Risk of injury, fire, or damage to the appliance.

- Before maintenance, deactivate the appliance and disconnect the mains plug from the mains socket.
- Make sure the appliance is cold. There is the risk that the glass panels can break.
- Replace immediately the door glass panels when they are damaged. Contact the Authorised Service Centre.
- Be careful when you remove the door from the appliance. The door is heavy!
- Clean regularly the appliance to prevent the deterioration of the surface material.
- Clean the appliance with a moist soft cloth. Only use neutral detergents. Do not use any abrasive products, abrasive cleaning pads, solvents or metal objects.
- If you use an oven spray, follow the safety instruction on it's packaging.
- Do not clean the catalytic enamel (if applicable) with any kind of detergent.

2.6 Internal lighting



WARNING!

Risk of electric shock.

- The type of light bulb or halogen lamp used for this appliance is for household appliances only. Do not use it for house lighting.
- Before replacing the lamp, disconnect the appliance from the power supply.
- Only use lamps with the same specifications.

2.7 Service

- To repair the appliance contact an Authorised Service Centre.
- Use original spare parts only.

2.8 Disposal



WARNING!

Risk of injury or suffocation.

- Disconnect the appliance from the mains supply.
- Cut off the mains electrical cable close to the appliance and dispose of it.
- Remove the door catch to prevent children or pets from becoming trapped in the appliance.

3. PRODUCT DESCRIPTION

3.1 General overview

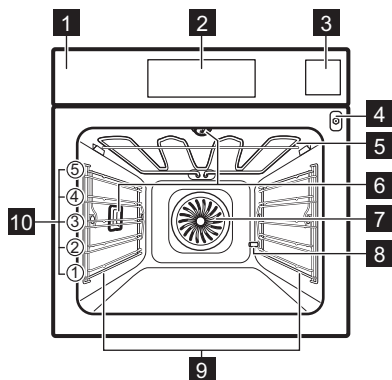

- 1 Control panel
- 2 Display
- 3 Water drawer
- 4 Socket for the food sensor
- 5 Heating element
- 6 Lamp
- 7 Fan
- 8 Descaling pipe outlet
- 9 Shelf support, removable
- 10 Shelf positions

3.2 Accessories

Wire shelf

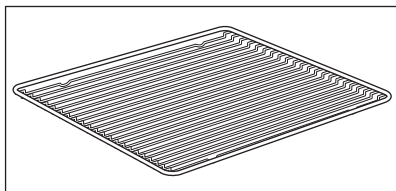

For cookware, cake tins, roasts.

Baking tray

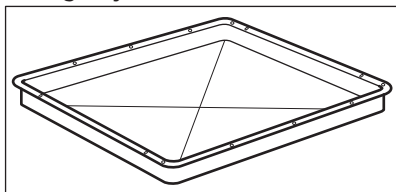

For cakes and biscuits.

Grill- / Roasting pan

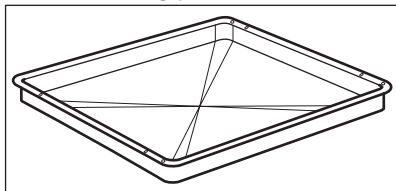

To bake and roast or as a pan to collect fat.

Food Sensor

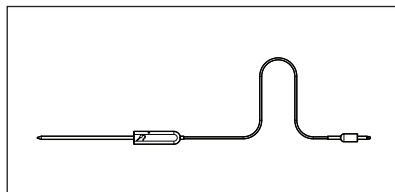

To measure the temperature inside the food.

Steam set

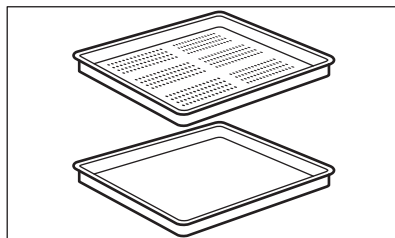

One unperforated and one perforated food container.

The steam set drains the condensing water away from the food during steam cooking. Use it to prepare vegetables, fish, chicken breast. The set is not

suitable for food that needs to soak in the water e.g. rice, polenta, pasta.

4. OPERATING THE APPLIANCE

4.1 Control panel

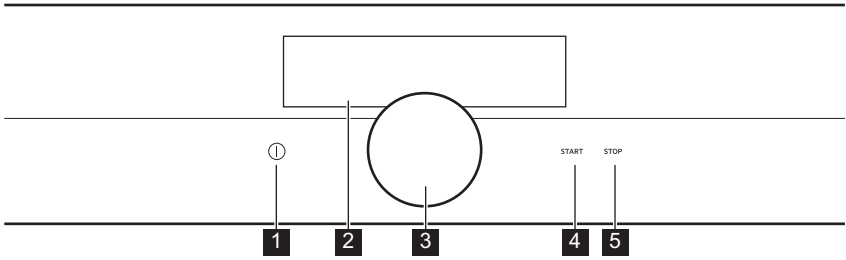

Function	Comment
1 On / Off	To turn the appliance on and off.
2 Display	Shows the current settings of the appliance.
3 Rotary knob	To adjust the settings and navigate through the menu. Press ① to turn the appliance on. Hold the rotary knob to turn on the setting screen. Hold and turn the rotary knob to navigate through the menu. Hold and press the rotary knob to confirm a setting or enter the selected submenu. To return to the previous menu find the option Back in the menu list or confirm a selected setting.
4 START	To turn on selected function.
5 STOP	To turn off selected function.

4.2 Display

After turning on, the display shows the last selected heating function mode.



The display with maximum number of functions set.

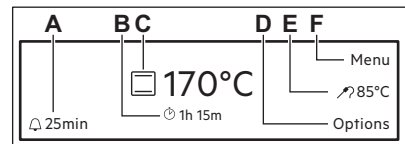

- A. Reminder
- B. Up Timer
- C. Heating function and temperature
- D. Options or Time of Day
- E. Duration time and End time of a function or Food Sensor
- F. Menu

5. BEFORE FIRST USE



WARNING!
Refer to Safety chapters.

5.1 Initial Cleaning

Remove all accessories and removable shelf supports from the oven.



Refer to "Care and cleaning" chapter.

Clean the oven and the accessories before first use.
Put the accessories and the removable shelf supports back to their initial position.

5.2 First Connection

After the first connection the software version will appear for 7 seconds.

You have to set the language, the Display Brightness, Water hardness and the Time of Day.

5.3 Setting the water hardness

The table below shows the water hardness range (dH) with the corresponding Calcium deposit and the quality of the water.



Water hardness		Calcium deposit (mmol/l)	Calcium deposit (mg/l)	Water classification
Class	dH			
1	0 - 7	0 - 1.3	0 - 50	Soft
2	7 - 14	1.3 - 2.5	50 - 100	Moderately hard
3	14 - 21	2.5 - 3.8	100 - 150	Hard
4	over 21	over 3.8	over 150	Very hard

When the water hardness exceeds the values in the table, fill the water drawer with bottled water.

1. Take the 4 colour change strip supplied with the steam set in the oven.
2. Put all the reaction zones of the strip into the water for approximately 1 second.
Do not put the strip into the running water.
3. Shake the strip to remove the excess of the water.
4. Wait 1 minute and check the water hardness with the table below.
The colours of the reaction zones continue to change. Do not check

the water hardness later than 1 minute after test.

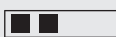
5. Set the water hardness: menu: Basic Settings.

Test strip	Water hardness
	1
	2
	3

Test strip	Water hardness
	4

You can change the water hardness in the menu: Basic Settings / Setup / Water hardness.

6. DAILY USE



WARNING!
Refer to Safety chapters.

6.1 Heating Functions

Turning the heating functions on and off.

1. Turn on the oven.
 2. Hold the rotary knob.
- The last used function is underlined.
3. Press the rotary knob to enter the submenu and turn it to select a heating function.
 4. Press the rotary knob to confirm.









5. Set the temperature and confirm.
6. Press **START**. Food Sensor can be plugged at any time before or during cooking process. Some functions contain a sequence of pop-ups. Press the rotary knob to go to the next pop-up. After the last confirmation the function starts.

To turn off a function press **STOP**.











The lamp may turn off automatically at a temperature below 60 °C during some oven functions.

Heating Functions: Specials







Heating function	Application
 Slow Cooking	To prepare tender, succulent roasts.
 Keep Warm	To keep food warm.
 Plate Warming	To preheat plates for serving.
 Preserving	To make vegetable preserves such as pickles.
 Drying	To dry sliced fruit, vegetables and mushrooms.
 Yogurt Function	Use this function to prepare yogurt. The lamp in this function is off.
 Defrost	This function can be used for defrosting frozen foods, such as vegetables and fruits. The defrosting time depends on the amount and size of the frozen food.
 Au Gratin	For dishes such as lasagna or potato gratin. Also to gratinate and brown.

Heating functions: Standard

Heating function	Application
 True Fan Cooking	To bake on up to three shelf positions at the same time and to dry food. Set the temperature 20 - 40 °C lower than for the function: Conventional Cooking.
 True Fan + Bottom	To bake food on one shelf position for a more intensive browning and a crispy bottom. Set the temperature 20 - 40 °C lower than for the function: Conventional Cooking.
 Conventional Cooking (Top / Bottom Heat)	To bake and roast food on one shelf position.
 Bottom + Grill + Fan	To make convenience food like e.g. french fries, potato wedges or spring rolls crispy.
 Grill	To grill flat food and to toast bread.
 Grill + Fan	To roast larger meat joints or poultry with bones on one shelf position. Also to make gratins and to brown.
 Bottom Heat	To bake cakes with crispy bottom and to preserve food.
 Moist Fan Baking	This function is designed to save energy during cooking. For more information refer to "Hints and tips" chapter, Moist Fan Baking. The oven door should be closed during cooking so that the function is not interrupted and to ensure that the oven operates with the highest energy efficiency possible. When you use this function, the temperature in the cavity may differ from the set temperature. Due to the use of the residual heat - the heating power may be reduced. For general energy saving recommendations refer to: "Energy Efficiency" chapter, Energy Saving. This function was used to comply with the energy efficiency class according to EN 60350-1.

Heating functions: Steam

Heating function	Application
 Full Steam	For steaming vegetables, side dishes or fish.

Heating function	Application
 Humidity High	The function is suitable for cooking delicate dishes like custards, flans, terrines and fish.
 Humidity Medium	The function is suitable for cooking stewed and braised meat as well as bread and sweet yeast dough. Due to the combination of steam and heat the meat gets a juicy and tender texture and yeast dough bakeries get a crispy and shiny surface.
 Humidity Low	The function is suitable for meat, poultry, oven dishes and casseroles. Thanks to the combination of steam and heat, meat gets a tender and juicy texture along with a crusty surface.
 Steam Regenerating	Food reheating with steam prevents surface drying. Heat is distributed in a gentle and even way, which allows to recover taste and aroma of food as just prepared. This function can be used to re-heat food directly on a plate. You can reheat more than one plate at the same time, using different shelf positions.
 SousVide Cooking	The function name refers to a method of cooking in vacuum sealed plastic pouches at low temperatures. Refer to the section SousVide Cooking below and the chapter "Hints and Tips" with the cooking tables to find more information.
 Bread Baking	Use this function to prepare bread and bread rolls with a very good professional-like result in terms of crispiness, colour and crust gloss.
 Dough Proving	Steam humidifying action improves and speeds up the dough proving, prevents surface drying and keeps the dough elastic.

Water drawer

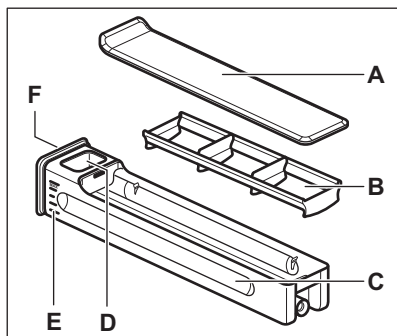

- A. Lid
- B. Wave-breaker
- C. Drawer body
- D. Water-filling hole
- E. Scale
- F. Front button

You can remove the water drawer from the oven. Push it gently on the front button. After you push the water drawer, it will self-extract from the oven.

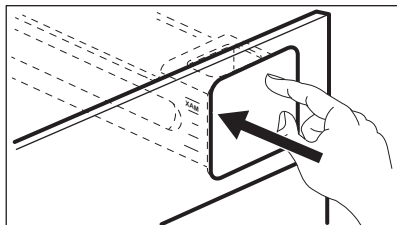

You can fill the water drawer in two ways:

- leave the water drawer inside the oven and fill it by means of a water jar,
- detach the water drawer from the oven and fill it from a water tap.

When you fill the water drawer from the water tap, carry the drawer in the horizontal position in order to avoid water spilling.

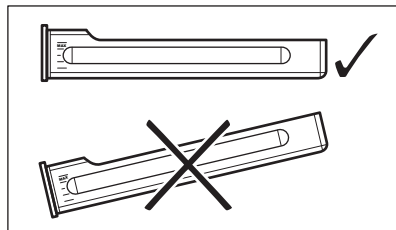

When you fill the water drawer, insert it in the same position. Push the front button until the water drawer is inside the oven.

Empty the water drawer after each use.



CAUTION!

Keep the water drawer away from hot surfaces.

Steam cooking

The water drawer cover is in the control panel.



WARNING!

Use only cold tap water. Do not use filtered (demineralised) or distilled water. Do not use other liquids. Do not put flammable or alcoholic liquids into the water drawer.

1. Press the cover of the water drawer to open it and extract it from the appliance.
2. Fill the water drawer with cold water to the maximum level (around 950 ml). The water supply is sufficient for approximately 50 minutes. Use the scale on the water drawer.
3. Push the water drawer to its initial position.



Wipe the wet water drawer with a soft cloth before you insert it in the appliance.

4. Turn on the appliance.
5. Set a steam heating function and the temperature.
6. If necessary, set the function:
Duration \rightarrow | or: End Time \rightarrow |.

The steam appears after approximately 2 minutes. When the appliance reaches the set temperature, the signal sounds. When the water drawer is running out of water, the signal sounds and the water drawer needs to be refilled to continue the steam cooking as described above.

The signal sounds at the end of the cooking time.

7. Turn off the appliance.
8. Empty the water drawer after the steam cooking is completed.



CAUTION!

The appliance is hot. There is a risk of burns. Be careful when you empty the water drawer.

9. After Steam Cooking steam can condensate on the bottom of the cavity. Always dry the bottom of the cavity when the appliance is cool.

Let the appliance dry fully with the door open. To speed up the drying you can close the door and heat up the appliance with function: True Fan Cooking at temperature 150°C for approximately 15 minutes.



At the end of a steam cooking, the cooling fan runs faster to remove the steam.

SousVide Cooking

- With no evaporative losses of flavour volatile and moisture, food keeps its full aroma.
- Tender texture of meat and fish.
- Food keeps all minerals and vitamins.
- Less spices are necessary as food keeps its natural flavour.
- Better workflow as it is not necessary to prepare and serve food at the same time and place.
- Low cooking temperature minimizes the risk of overcooking.
- Portioning of the food makes it easy to hold.

Preparing the food

1. Clean and cut the ingredients.

2. Season the ingredients.
3. Fill the ingredients in suitable vacuum bags.
4. Vacuum seal the bag to make sure that you remove as much air as possible.
5. Cold storage of the bags is mandatory in case the cooking procedure is not done immediately.
6. Continue with the function SousVide Cooking following applicable cooking table indications for the considered type of food or the assisted cooking recipes.
7. Open the pouch and serve.
8. Optionally finish the food with a final searing or grilling e.g. for meat to achieve a nice crust and the typical roast flavour.



Cooking with this function causes residual water on the vacuum bags and in the cavity. After the cooking process open the door carefully to avoid the water dropping on the furniture. Use a plate and a towel to take out the vacuum bags. Dry out the door, the water drop collector in the bottom and the cavity with a soft cloth or a sponge. Let the oven dry fully with the door open. To speed up the drying you can heat up the oven with hot air at temperature 150 °C for approximately 15 minutes.

6.2 Menu - overview

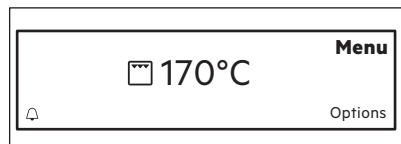

Menu

Menu item	Application
Assisted Cooking	Contains a list of automatic programmes.
Cleaning	Contains a list of cleaning programmes.
Basic Settings	Used to set the appliance configuration.

Submenu for: Cleaning

Submenu	Description
Steam Cleaning	Procedure for cleaning the appliance when it is slightly soiled and not burned several times.
Steam Cleaning Plus	Procedure for cleaning stubborn dirt with the support of an oven cleaner.
Descaling	Procedure for cleaning the steam generation circuit from residual limestone.
Rinsing	Procedure for rinsing and cleaning the steam generation circuit after frequent use of the steam functions.

Submenu for: Basic Settings

Submenu	Description
Child Lock	When the Child Lock is on, the oven cannot be activated accidentally. You can activate and deactivate this function via Basic Setting Menu. Once activated, Child Lock appears on the display when you turn on the appliance. To enable the oven use, choose the code letters with the rotary knob in the following order: A B C. When the Child Lock is on and the oven is turned off the oven door are locked.
Fast Heat Up	Decreases heat up time as a default. Note that it is available only for some of the heating functions.
Heat + Hold	Keeps the prepared food warm for 30 minutes after a cooking is finished. To turn it off earlier press the rotary knob. When this function is active the message "Keep warm started" appears on the display. Note that it is available only for some of the heating functions and if Duration is set.
Time Extension	To extend predefined cooking time. Note that it is available only for some of the heating functions.
Setup	To set the oven configuration.
Service	Shows the software version and configuration.

Submenu for: Setup

Submenu	Description
Language	Sets the language for the display.
Time of Day	Sets the current time and date.
Key Tones	Activates and deactivates the tone of the touch fields. It is not possible to deactivate the tone of the ON / OFF and STOP.
Alarm/Error Tones	Activates and deactivates the alarm tones.
Buzzer Volume	Adjusts the volume of press-tones and signals by degrees.
Display Brightness	Adjusts the display brightness by degrees.
Water hardness	Sets the water hardness.

Submenu for: Service

Submenu	Description
DEMO	Activation / deactivation code: 2468
Show Licenses	Information about licenses.
Show Software Version	Information about software version.
Factory Settings	Reset to factory settings.

Submenu for: Assisted Cooking

Every dish in this submenu has a proposed function and temperature. Those parameters can be adjusted manually according to the user's preference.

For some of the dishes You can also choose way of cooking:

- Weight Automatic
- Food Sensor

The level to which a dish is cooked:

- Rare or Less
- Medium
- Well Done or More

Food Category: Meat and Fish

Meat	
Beef	Sirloin
	Roast
	Fillet Steak
	Prime Boiled Beef
	Meat Loaf
	Scandinavian Beef

Meat		
Pork	Tenderloin	Fresh
		Smoked
	Roast	
	Ham	Roasted
		Steamed
	Knuckle, precooked	
	Ribs	
Sausages		
Veal	Tenderloin	
	Roast	
	Knuckle	
Lamb	Tenderloin	
	Roast	
	Saddle	
	Leg	
Game	Venison	Saddle
		Haunch
	Hare	Saddle
		Leg
Poultry		
Chicken	Whole	
	Half	
	Breast	Steamed
		SousVide
	Legs	
Wings		
Duck	Whole:	
	Breast	
Goose		

Poultry		
Turkey	Whole:	
	Breast	
Fish		
Whole Fish	Small	Roasted
		Steamed
	Medium	Roasted
		Steamed
	Large	Roasted
		Steamed
Fillets	Thin	Steamed
		SousVide
	Thick	Steamed
		SousVide
Fish Bakes		
Fish Fingers		
Seafood		
Prawns	Steamed	
	SousVide	
Mussels	Steamed	
	SousVide	
Scallops		

Food Category: Side / Oven Dishes

Dishes		
Side Dishes	Potatoes Fresh	Steamed
		SousVide
	Potatoes Frozen	French Fries
		Croquettes
		Wedges
		Hash Browns
	Rice	
	Pasta, fresh	
	Polenta	
	Dumplings	Bread Dumplings
Potato Dumplings		
Yeast Dump- lings		
Oven Dishes	Lasagne	
	Potato Gra- tin	
	Pasta Bake	
	Vegetables au Gratin	
	Casserole, savoury	
	Casserole, vegetable	
Legumes and Grains		
Terrines		
Eggs	Soft Boiled	
	Medium	
	Hard boiled	
	Eggs, baked	

Food Category: Savoury Baking

Dish		
Pizza	Fresh	Thin
		Thick
	Frozen	Thin
		Thick
		Snacks
Chilled		
Quiche	Thin	
	Thick	
Bread	Fresh	Baguette
		Ciabatta
		White Bread
		Dark Bread
		Rye Bread
		All Grain Bread
	Frozen	Unleavened Bread
		Yeast Plait
	Pre-baked	Baguette
		Bread
	Rolls	Fresh
Frozen		
Pre-baked		

Food Category: Desserts / Baking

Dish		
Cake in Tin	Almond Cake	
	Apple Pie	
	Cheese Cake	
	Apple Cake, covered	
	Short Pastry Base	
	Sponge Flan Base	
	Madeira Cake	
	Sponge Cake	
	Tarts	
	Cake on Tray	Froz. Apple Strudel
Brownies		
Cheese Cake		
Christmas Stollen		
Fruit Flan		Short Pastry
		Sponge Dough
		Yeast Dough
Sponge Cake		
Sugar Cake		
Swiss Roll		
Swiss Tarte, sweet		
Yeast Cake		

Dish	
Small Pastry	Cakes, small
	Cream Puffs
	Eclairs
	Macaroons
	Muffins
	Pastry Stripes
	Puff Pastry
	Short Pastry Biscuits
	Flan
	Custard
Casserole, sweet	
Sweet Dumplings	

Food Category: Vegetables

Dish	
Artichokes	Steamed
	SousVide
Asparagus, green	Steamed
	SousVide
Asparagus, white	Steamed
	SousVide
Beetroot	
Black Salsify	
Broccoli	Florets
	Whole
Brussels Sprouts	
Cabbage Turnip	
Carrots	Steamed
	SousVide

Dish	
Cauliflower	Florets
	Whole
Celery	Steamed
	SousVide
Celery Root	
Courgette Slices	Steamed
	SousVide
Eggplant	Steamed
	SousVide
Fennel	Steamed
	SousVide
Green Beans	
Leek Rings	Steamed
	SousVide
Mushroom Slices	
Peas	
Pepper	Steamed
	SousVide

Dish
Pumpkin
Savoy Cabbage
Spinach, fresh
Tomatoes

Food Category: Fruits

Dish
Apples
Mangos
Nectarines
Peaches
Pears
Pineapple
Plums

6.3 Options

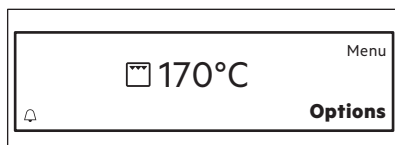





Options	Description
Timer Settings	Contains a list of clock functions.
Fast Heat Up	To decrease heat up time in the currently running heating function. On / Off
Set + Go	To set a function and turn it on later. Once set, the message "Set&Go active" appears on the display. Press Start to turn it on. When this function is active the message disappears from the display and the oven starts to work. Note that it is available only for some of the heating functions and if Duration / End Time is set.

6.4 Residual heat

When you turn off the oven, the display shows the residual heat. You can use the heat to keep the food warm.

7. CLOCK FUNCTIONS

7.1 Timer Settings

Clock function	Application
 Up Timer	Automatically monitors how long the function operates. The visibility of the Up Timer can be turned on and off.
 Duration	To set the length of an operation. ¹⁾
 End Time	To set the switch-off time for a heating function. This option is available only when the Duration is set. Use the functions Duration and End Time at the same time to automatically turns on and off the oven on a given time later. ¹⁾
 Reminder	To set a countdown. ¹⁾ This function has no effect on the operation of the oven. Choose  and set the time. When the time ends the signal sounds. Press the rotary knob to stop the signal. When the oven is turned off press the rotary knob to turn on this function.

¹⁾ Maximum 23 h 59 min

8. USING THE ACCESSORIES



WARNING!
Refer to Safety chapters.



CAUTION!
Use only the accessory supplied and the original replacement parts.

8.1 Food Sensor

Food Sensor measures temperature inside the food. When the food is at the set temperature, the appliance deactivates.

There are two temperatures to be set:

- the oven temperature (minimum 120 °C),
- the food core temperature.

Directions for the best results:

- Ingredients should be at room temperature.
- The Food Sensor cannot be used for liquid dishes.
- During cooking the Food Sensor must remain in the dish and the plug in the socket.
- Use recommended food core temperature settings.

**WARNING!**

Refer to "Hints and tips" chapter.



The appliance calculates an approximate end of cooking time. It depends on the quantity of food, the set oven function and temperature.

Food categories: meat, poultry and fish

1. Activate the oven.
2. Insert the tip of the Food Sensor into the centre of meat or fish, in the thickest part if possible. Make sure that at least 3/4 of the Food Sensor is inside of the dish.
3. Put the plug of the Food Sensor into the socket at the front of the oven.

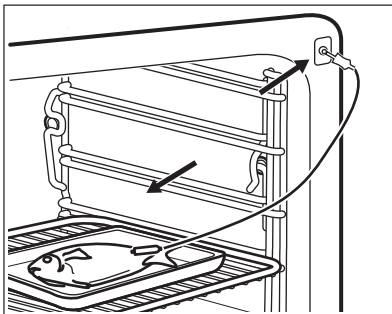
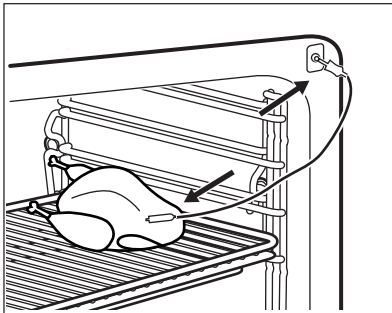

The display shows: Food Sensor.

4. Set the core temperature.
5. Set a heating function and, if necessary, the oven temperature.

When the dish reaches the set temperature the signal sounds. The oven turns off automatically.

6. Press the rotary knob to stop the signal.
7. Remove the Food Sensor plug from the socket and remove the dish from the oven.

**WARNING!**

There is a risk of burns as the Food Sensor becomes hot. Be careful when you unplug it and remove it from the food.

Food category: casserole

1. Activate the oven.
2. Place half of the ingredients in a baking dish.
3. Insert the tip of the Food Sensor exactly in the centre of the casserole. The Food Sensor should be stabilized in one place during baking. Use a solid ingredient to achieve that. Use the rim of the baking dish to support the silicone handle of the Food Sensor. The tip of the Food Sensor should not touch the bottom of a baking dish.

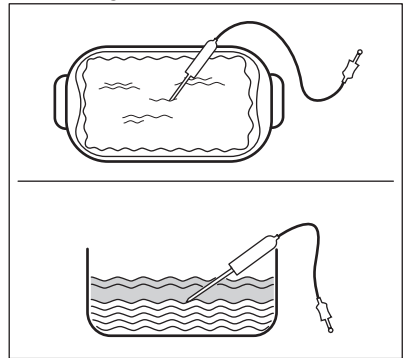

4. Cover the Food Sensor with the remaining ingredients.
5. Put the plug of the Food Sensor into the socket at the front of the oven.

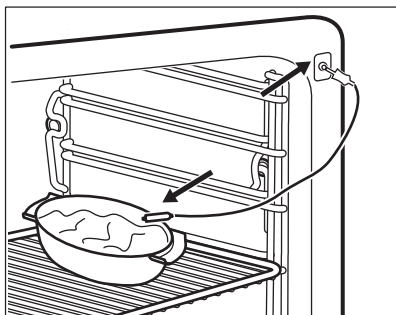

The display shows: Food Sensor.

6. Set the core temperature.
7. Set a heating function and, if necessary, the oven temperature. When the dish reaches the set temperature, an acoustic signal sounds. The oven turns off automatically.
8. Press the rotary knob to stop the signal.
9. Remove the Food Sensor plug from the socket and remove the dish from the oven.



WARNING!

There is a risk of burns as the Food Sensor becomes hot. Be careful when you unplug it and remove it from the food.

Changing the core temperature

You can change the core temperature and the oven temperature at any time during cooking.

1. Select  on the display.
2. Turn the rotary knob to change the temperature.
3. Press to confirm.

8.2 Inserting the accessories

Wire shelf:

Push the shelf between the guide bars of the shelf support and make sure that the feet point down.

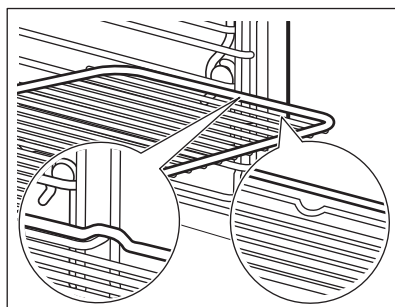

Baking tray/ Deep pan:

Push the baking tray / deep pan between the guide bars of the shelf support.

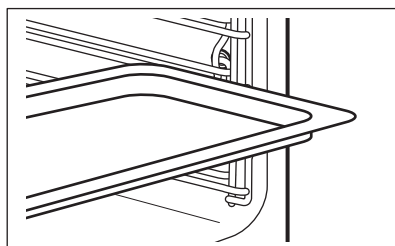

Wire shelf and baking tray / deep pan together:

Push the baking tray / deep pan between the guide bars of the shelf support and the wire shelf on the guide bars above.

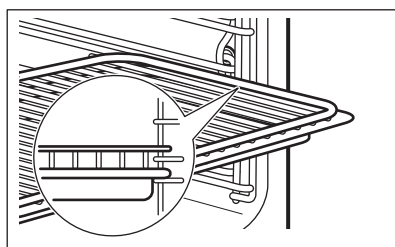

Small indentation at the top increase safety. The indentations are also anti-tip devices. The high rim around the shelf prevents cookware from slipping of the shelf.

9. ADDITIONAL FUNCTIONS

9.1 Automatic Switch-off

For safety reasons the oven turns off automatically after some time if a heating function works and you do not change any settings.

Temperature (°C)	Switch-off time (h)
30 - 115	12.5
120 - 195	8.5
200 - 230	5.5

 The Automatic switch-off does not work with the functions: Light, Food Sensor, Duration, End Time.

9.2 Cooling fan

When the oven operates, the cooling fan turns on automatically to keep the surfaces of the oven cool. If you turn off the oven, the cooling fan can continue to operate until the oven cools down.

10. HINTS AND TIPS



WARNING!
Refer to Safety chapters.



The temperature and baking times in the tables are guidelines only. They depend on the recipes and the quality and quantity of the ingredients used.

10.1 Inner side of the door

On the inner side of the door you can find:

- the numbers of the shelf positions.
- information about the heating functions, recommended shelf positions and temperatures for dishes.

10.2 Advice for special heating functions of the oven

Keep Warm

The function allows you to keep food warm. The temperature is set automatically to 80 °C.

Plate Warming

The function allows you to warm plates and dishes before serving. The temperature is set automatically to 70 °C.

Place plates and dishes in stacks evenly on the wire shelf. Use the first shelf position. After half of the warming time switch their places.

Defrost

Remove the food packaging and put the food on a plate. Do not cover the food, as it can extend the defrosting time. Use the first shelf position.

10.3 SousVide Cooking

This function uses lower cooking temperatures than normal cooking.

SousVide Cooking Recommendations

Use high quality and fresh raw food. Always clean the food before cooking. Be careful when using raw eggs.

Low temperatures are suitable only for the types of food that can be eaten raw.

Do not cook the food for a long time when you are using the temperature below 60 °C.

Boil ingredients containing alcohol before vacuum packing.

Put the vacuum bags on the grid side by side.

You can keep the cooked food in the fridge for 2 – 3 days. Cool down the food quickly (by using ice bath).

Do not use this function for reheating food leftovers.

Vacuum Packing

Use only the vacuum bags and chamber vacuum sealer recommended for sous-vide cooking. Only this type of vacuum sealer can vacuum pack liquids.

Do not reuse vacuum bags.

For faster and better results set the maximum vacuum degree.

To guarantee a safe closing of the vacuum bag, make sure that the area subject to the seal is clean.

Make sure that the edges of the inner side of the vacuum bag are clean, before sealing it.

10.4 SousVide Cooking: Meat

Use only boneless meat to avoid piercing the vacuum bags.

For the poultry fillets to taste better, fry them on the skin side before vacuum packing.

Use the third shelf position.

Beef

Food	Temperature (°C)	Time (min)
Beef fillet medium, 4 cm thick, 0.8 kg	60	110 - 120
Beef fillet well done, 4 cm thick, 0.8 kg	65	90 - 100
Veal fillet medium, 4 cm thick, 0.8 kg	60	110 - 120
Veal fillet well done, 4 cm thick, 0.8 kg	65	90 - 100

Lamb / Game

Food	Temperature (°C)	Time (min)
Lamb rare, 3 cm thick, 0.6 - 0.65 kg	60	180 - 190
Lamb medium, 3 cm thick, 0.6 - 0.65 kg	65	105 - 115
Boar, 3 cm thick, 0.6 - 0.65 kg	90	60 - 70
Rabbit, 1.5 cm thick, 0.6 - 0.65 kg	70	50 - 60

Poultry

Food	Temperature (°C)	Time (min)
Chicken breast, 3 cm thick, 0.75 kg	70	70 - 80
Duck breast, 2 cm thick, 0.9 kg	60	140 - 160
Turkey breast, 2 cm thick, 0.8 kg	70	75 - 85

10.5 SousVide Cooking: Fish and seafood

Dry the fish fillets with a paper towel before you put them in a vacuum bag.

Add a cup of water in the vacuum bag when you cook the mussels.

Use the third shelf position.

Food	Thickness of food	Temperature (°C)	Time (min)
Sea bream fillet, 0.5 kg	4 fillets 1 cm	70	25

Food	Thickness of food	Temperature (°C)	Time (min)
Sea bass fillet, 0.5 kg	4 fillets 1 cm	70	25
Cod fish, 0.65 kg	2 fillets 2 cm	65	70 - 75
Scallops, 0.65 kg	big size	60	100 - 110
Mussels with shell, 1 kg		95	20 - 25
Prawns without shell, 0.5 kg	big size	75	26 - 30
Octopus, 1 kg		85	100 - 110
Trout fillet, 0.65 kg ¹⁾	2 fillets 1.5 cm	65	55 - 65
Salmon fillet, 0.8 kg ¹⁾	3 cm	65	100 - 110

¹⁾ To prevent protein leak soak the fish in a 10 % salt solution (100 g salt in 1 litre of water) for 30 min and dry with a paper towel before you put it in a vacuum bag.

10.6 SousVide Cooking: Vegetables

- Peel the vegetables where necessary.
- Some vegetables can change their colour when you peel them and cook in a vacuum packing. For better

results cook the food immediately after you prepare it.

- To keep the colour of the artichokes, put them in water with lemon juice, after you clean and cut them.

Food	Thickness of food	Amount of food for 4 persons (g)	Temperature (°C)	Time (min)	Shelf position
Asparagus green	whole	700 - 800	90	40 - 50	3
Asparagus white	whole	700 - 800	90	50 - 60	3
Courgette	slices of 1 cm	700 - 800	90	35 - 40	3
Leek	stripes or rings	600 - 700	95	40 - 45	3
Eggplant	slices of 1 cm	700 - 800	90	30 - 35	3
Pumpkin	pieces with thickness of 2 cm	700 - 800	90	25 - 30	3
Pepper	stripes or quarter	700 - 800	95	35 - 40	3
Celery	rings of 1 cm	700 - 800	95	40 - 45	3
Carrots	slices of 0.5 cm	700 - 800	95	35 - 45	3
Celery root	slices of 1 cm	700 - 800	95	45 - 50	3

Food	Thickness of food	Amount of food for 4 persons (g)	Temperature (°C)	Time (min)	Shelf position
Fennel	slices of 1 cm	700 - 800	95	35 - 45	3
Potatoes	slices of 1 cm	800 - 1000	95	35 - 45	3
Artichoke hearts	cut in quarter	400 - 600	95	45 - 55	3

10.7 SousVide Cooking: Fruits and sweets

- Peel the fruits, remove the seeds and cores where necessary
- To keep the colour of the apples and pears, put them in water with lemon juice, after you clean and cut them.
- For better results cook the food immediately after you prepare it.

Food	Thickness of food	Amount of food for 4 persons (g)	Temperature (°C)	Time (min)	Shelf position
Peach	cut in halves	4 fruits	90	20 - 25	3
Plum	cut in halves	600 g	90	10 - 15	3
Mango	cut in cubes of about 2 x 2 cm	2 fruits	90	10 - 15	3
Nectarine	cut in halves	4 fruits	90	20 - 25	3
Pineapple	slices 1 cm	600 g	90	20 - 25	3
Apple	cut in quarters	4 fruits	95	25 - 30	3
Pear	cut in halves	4 fruits	95	15 - 30	3
Vanilla creme	350 g in each bag	700 g	85	20 - 22	3

10.8 Steam cooking

Use only heat and corrosion resistant or chrome steel cookware.

When you cook on more than one level make sure that there is a distance between the shelves to let the steam circulate.

Start cooking with a cold oven unless the preheating is recommended in the below table.

10.9 Full Steam



WARNING!

Be careful when you open the oven door when the function is on. Steam can release.

Sterilisation

This function allows you to sterilise containers (e.g. baby bottles).

Put the clean containers up side down in the centre of the shelf on the first shelf position.

Fill the drawer with the maximum quantity of water and set the time to 40 minutes.

Cooking

This function allows you to prepare all types of food, fresh or frozen. You can use it to cook, warm, defrost, poach or blanch vegetables, meat, fish, pasta, rice, semolina and eggs.

You can prepare a full meal at one time. Cook together dishes with similar cooking times. Use the largest quantity of water required when you cook dishes at one time.

Use the second shelf position.

Set the temperature to 99 °C unless the below table recommends different setting.

Vegetables

Food	Time (min)
Peeling tomatoes	10
Broccoli, florets ¹⁾	13 - 15
Vegetables, blanched	15
Mushroom slices	15 - 20
Peppers, strips	15 - 20
Spinach, fresh	15 - 20
Asparagus, green	15 - 25
Aubergines	15 - 25
Courgette, slices	15 - 25
Pumpkin, cubes	15 - 25
Tomatoes	15 - 25
Beans, blanched	20 - 25
Lamb's lettuce, florets	20 - 25
Savoy cabbage	20 - 25
Celery, cubed	20 - 30
Leeks, rings	20 - 30
Peas	20 - 30

Food	Time (min)
Snow peas (kaiser peppers)	20 - 30
Sweet potatoes	20 - 30
Asparagus, white	25 - 35
Brussels sprouts	25 - 35
Carrots	25 - 35
Cauliflower, florets	25 - 35
Fennel	25 - 35
Kohlrabi, strips	25 - 35
White haricot beans	25 - 35
Broccoli, whole	30 - 40
Sweet corn on the cob	30 - 40
Black salsify	35 - 45
Cauliflower, whole	35 - 45
Green beans	35 - 45
Cabbage white or red, stripes	40 - 45
Artichokes	50 - 60
Dried beans, soaked (water / beans ratio 2:1)	55 - 65
Sauerkraut	60 - 90
Beetroot	70 - 90

¹⁾ Preheat the oven for 5 minutes.

Side dishes / accompaniments

Food	Time (min)
Couscous (water / couscous ratio 1:1)	15 - 20
Tagliatelle, fresh	15 - 25
Semolina pudding (milk / semolina ratio 3.5:1)	20 - 25
Lentils, red (water / lentils ratio 1:1)	20 - 30

Food	Time (min)
Spaetzle	25 - 30
Bulgur (water / bulgur ratio 1:1)	25 - 35
Yeast dumplings	25 - 35
Fragrant rice (water / rice ratio 1:1)	30 - 35
Boiled potatoes, quartered	35 - 45
Bread dumpling	35 - 45
Potato dumplings	35 - 45
Rice (water / rice ratio 1:1) ¹⁾	35 - 45
Polenta (liquid ratio 3:1)	40 - 50

Food	Time (min)
Rice pudding (milk / rice ratio 2.5:1)	40 - 55
Unpeeled potatoes, medium	45 - 55
Lentils, brown and green (water / lentils ratio 2:1)	55 - 60

¹⁾ The ratio of water to rice can change according to the type of rice.

Fruits

Food	Time (min)
Apple slices	10 - 15
Hot berries	10 - 15
Chocolate melting	10 - 20
Fruit compote	20 - 25

Fish

Food	Temperature (°C)	Time (min)
Flat fish fillet	80	15
Prawns, fresh	85	20 - 25
Mussels	99	20 - 30
Salmon fillets	85	20 - 30
Trout 0.25 kg	85	20 - 30
Prawns, frozen	85	30 - 40
Salmon trout 1 kg	85	40 - 45

Meat

Food	Temperature (°C)	Time (min)
Chipolatas	80	15 - 20
Bavarian veal sausage (white sausage)	80	20 - 30
Vienna sausage	80	20 - 30
Chicken breast, poached	90	25 - 35
Cooked ham 1 kg	99	55 - 65
Chicken, poached 1 - 1.2 kg	99	60 - 70

Food	Temperature (°C)	Time (min)
Kasseler (smoked loin of pork), poached	90	70 - 90
Veal / pork loin 0.8 - 1 kg	90	80 - 90
Tafelspitz (prime boiled beef)	99	110 - 120

Eggs

Food	Time (min)
Eggs, soft-boiled	10 - 11
Eggs, medium-boiled	12 - 13
Eggs, hard-boiled	18 - 21

- Set the function: Grill + Fan to roast meat.
- Add the prepared vegetables and side dishes.
- Cool down the oven to a temperature of around 90 °C. You can open the oven door to the first position for approximately 15 minutes.
- Set the function: Full Steam. Cook all dishes together until they are ready.

10.10 Grill + Fan and Full Steam combined

You can combine these functions to cook meat, vegetables and side dishes at one time.

Food	Grill + Fan (first step: cook meat)			Full Steam (second step: add vegetables)		
	Temperature (°C)	Time (min)	Shelf position	Temperature (°C)	Time (min)	Shelf position
Roast beef 1 kg Brussels sprouts, polenta	180	60 - 70	meat: 1	99	40 - 50	meat: 1 vegetables: 3
Roast pork 1 kg, Potatoes, vegetables, gravy	180	60 - 70	meat: 1	99	30 - 40	meat: 1 vegetables: 3
Roast veal 1 kg, Rice, vegetables	180	50 - 60	meat: 1	99	30 - 40	meat: 1 vegetables: 3

10.11 Humidity Low

Food	Temperature (°C)	Time (min)	Shelf position
Roast pork 1000 g	160 - 180	90 - 100	2
Roast beef 1000 g	180 - 200	60 - 90	2
Roast veal 1000 g	180	80 - 90	2
Meat loaf, uncooked, 500 g	180	30 - 40	2
Smoked loin of pork 600 - 1000 g (soak for 2 hours)	160 - 180	60 - 70	2
Chicken 1000 g	180 - 210	50 - 60	2
Duck 1500 - 2000 g	180	70 - 90	2
Goose 3000 g	170	130 - 170	1
Potato gratin	160 - 170	50 - 60	2
Pasta bake	170 - 190	40 - 50	2
Lasagne	170 - 180	45 - 55	2
Misc. types of bread 500 - 1000 g	180 - 190	45 - 60	2
Bread rolls	180 - 210	25 - 35	2
Ready-to-bake rolls	200	15 - 20	2
Ready-to-bake baguettes 40 - 50 g	200	15 - 20	2
Ready-to-bake baguettes 40 - 50 g, frozen	200	25 - 35	2

10.12 Humidity Cooking - Humidity High

Food	Temperature (°C)	Time (min)	Shelf position
Custard / flan in individual dishes ¹⁾	90	35 - 45	2
Baked eggs ¹⁾	90 - 110	15 - 30	2
Terrine ¹⁾	90	40 - 50	2
Thin fish fillet	85	15 - 25	2
Thick fish fillet	90	25 - 35	2

Food	Temperature (°C)	Time (min)	Shelf position
Small fish up to 0,35 kg	90	20 - 30	2
Whole fish up to 1 kg	90	30 - 40	2
Oven dumplings	120 - 130	40 - 50	2

¹⁾ Continue for a further half an hour with the door closed.

10.13 Humidity Cooking - Humidity Medium

Food	Temperature (°C)	Time (min)	Shelf position
Various types of bread 0,5 - 1kg	180 - 190	45 - 60	2
Bread rolls	180 - 200	25 - 35	2
Sweet bread	160 - 170	30 - 45	2
Sweet yeast dough bakeries	170 - 180	20 - 35	2
Sweet oven dishes	160 - 180	45 - 60	2
Stewed / braised meat	140 - 150	100 - 140	2
Spare ribs	140 - 150	75 - 100	2
Roasted fish fillet	170 - 180	25 - 40	2
Roasted fish	170 - 180	35 - 45	2

10.14 Steam Regenerating

Food	Temperature (°C)	Time (min)	Shelf position
One-plate dishes	110	10 - 15	2
Pasta	110	10 - 15	2
Rice	110	10 - 15	2
Dumplings	110	15 - 25	2

10.15 Yogurt Function

This function allows you to prepare yogurt.

Mix 0.25 kg of yogurt with 1 l of milk. Fill it in yogurt jars.

If you use raw milk, boil it first and let it cool down to 40 °C.

Use second shelf position.

Set the temperature to 42 °C.

Food	Time (h)
Yogurt, creamy	5 - 6
Yogurt, thick	7 - 8

10.16 Baking

- Use the lower temperature the first time.
- You can extend baking times by 10 – 15 minutes if you bake cakes on more than one shelf position.

- Cakes and pastries at different heights do not always brown equally. There is no need to change the temperature setting if an unequal browning occurs. The differences equalize during baking.
- Trays in the oven can twist during baking. When the trays become cold again, the distortions disappear.

10.17 Tips on baking

Baking results	Possible cause	Remedy
The bottom of the cake is not browned sufficiently.	The shelf position is incorrect.	Put the cake on a lower shelf.
The cake sinks and becomes soggy, lumpy or streaky.	The oven temperature is too high.	The next time you bake, set a slightly lower oven temperature.
	The baking time is too short.	Set a longer baking time. You cannot decrease baking times by setting higher temperatures.
	There is too much liquid in the mixture.	Use less liquid. Be careful with mixing times, especially if you use a mixing machine.
The cake is too dry.	The oven temperature is too low.	The next time you bake, set a higher oven temperature.
	The baking time is too long.	The next time you bake, set a shorter baking time.
The cake browns unevenly.	The oven temperature is too high and the baking time is too short.	Set a lower oven temperature and a longer baking time.
	The mixture is unevenly distributed.	Spread the mixture evenly on the baking tray.
The cake is not ready in the baking time given.	The oven temperature is too low.	The next time you bake, set a slightly higher oven temperature.

10.18 Baking on one level

Baking in tins

Food	Function	Temperature (°C)	Time (min)	Shelf position
Ring cake / Brioche	True Fan Cooking	150 - 160	50 - 70	1
Madeira cake / Fruit cakes	True Fan Cooking	140 - 160	70 - 90	1
Flan base - short pastry	True Fan Cooking	150 - 160 ¹⁾	20 - 30	2
Flan base - sponge mixture	True Fan Cooking	150 - 170	20 - 25	2
Cheesecake	Conventional Cooking	170 - 190	60 - 90	1

1) Preheat the oven.

Cakes / pastries / breads on baking trays

Food	Function	Temperature (°C)	Time (min)	Shelf position
Plaited bread / Bread crown	Conventional Cooking	170 - 190	30 - 40	3
Christmas stollen	Conventional Cooking	160 - 180 ¹⁾	50 - 70	2
Bread (rye bread): 1. First 20 minutes: 2. After that reduce to:	Conventional Cooking	1. 230 ¹⁾ 2. 160 - 180	1. 20 2. 30 - 60	1
Cream puffs / Eclairs	Conventional Cooking	190 - 210 ¹⁾	20 - 35	3
Swiss roll	Conventional Cooking	180 - 200 ¹⁾	10 - 20	3
Cake with crumble topping (dry)	True Fan Cooking	150 - 160	20 - 40	3
Buttered almond cake / Sugar cakes	Conventional Cooking	190 - 210 ¹⁾	20 - 30	3
Fruit flans	Conventional Cooking	180	35 - 55	3

Food	Function	Temperature (°C)	Time (min)	Shelf position
Yeast cakes with toppings (e.g. quark, cream, custard)	Conventional Cooking	160 - 180 ¹⁾	40 - 60	3

¹⁾ Preheat the oven.

Biscuits

Food	Function	Temperature (°C)	Time (min)	Shelf position
Short pastry / sponge mixture	True Fan Cooking	150 - 160	15 - 25	3
Meringues	True Fan Cooking	80 - 100	120 - 150	3
Macaroons	True Fan Cooking	100 - 120	30 - 50	3
Yeast dough biscuits	True Fan Cooking	150 - 160	20 - 40	3
Puff pastries	True Fan Cooking	170 - 180 ¹⁾	20 - 30	3
Rolls	Conventional Cooking	190 - 210 ¹⁾	10 - 25	3

¹⁾ Preheat the oven.

10.19 Bakes and gratins

Food	Function	Temperature (°C)	Time (min)	Shelf position
Pasta bake	Conventional Cooking	180 - 200	45 - 60	1
Lasagne	Conventional Cooking	180 - 200	25 - 40	1
Vegetables au gratin ¹⁾	Grill + Fan	170 - 190	15 - 35	1
Baguettes with melted cheese	True Fan Cooking	160 - 170	15 - 30	1
Milk rice	Conventional Cooking	180 - 200	40 - 60	1
Fish bakes	Conventional Cooking	180 - 200	30 - 60	1

Food	Function	Temperature (°C)	Time (min)	Shelf position
Stuffed vegetables	True Fan Cooking	160 - 170	30 - 60	1

1) Preheat the oven.

10.20 Moist Fan Baking

Food	Temperature (°C)	Time (min)	Shelf position
Pasta gratin	210 - 220	45 - 60	3
Bread pudding	200 - 210	45 - 60	3
Rice pudding	200 - 210	45 - 60	3

10.21 Multilevel Baking

Use the function: True Fan Cooking.

Cakes / pastries / breads on baking trays

Food	Temperature (°C)	Time (min)	Shelf position	
			2 positions	3 positions
Cream puffs / Eclairs	160 - 180 ¹⁾	25 - 45	1 / 4	-
Dry streusel cake	150 - 160	30 - 45	1 / 4	-

1) Preheat the oven.

Biscuits

Food	Temperature (°C)	Time (min)	Shelf position	
			2 positions	3 positions
Short pastry / sponge mixture biscuits	150 - 160	20 - 40	1 / 4	1 / 3 / 5
Meringues	80 - 100	130 - 170	1 / 4	-
Macaroons	100 - 120	40 - 80	1 / 4	-
Yeast dough biscuits	160 - 170	30 - 60	1 / 4	-
Puff pastries	170 - 180 ¹⁾	30 - 50	1 / 4	-
Rolls	180	20 - 30	1 / 4	-

1) Preheat the oven.

10.22 Crispy baking with True Fan + Bottom

Food	Temperature (°C)	Time (min)	Shelf position
Pizza (thin)	210 - 230 ¹⁾²⁾	15 - 25	2
Pizza (thick)	180 - 200	20 - 30	2
Tarts	180 - 200	40 - 55	1
Spinach flan	160 - 180	45 - 60	1
Quiche Lorraine / Swiss Flan	170 - 190	45 - 55	1
Apple cake, covered	150 - 170	50 - 60	1
Vegetable pie	160 - 180	50 - 60	1
Unleavened bread	210 - 230 ¹⁾	10 - 20	2
Puff pastry flan	160 - 180 ¹⁾	45 - 55	2
Flammekuchen	210 - 230 ¹⁾	15 - 25	2
Pierogi	180 - 200 ¹⁾	15 - 25	2

¹⁾ Preheat the oven.

²⁾ Use a deep pan.

10.23 Roasting

Use heat-resistant ovenware.

Roast large roasting joints directly in the tray or on the wire shelf placed above the tray.

Put some water in the tray to prevent the meat juices or fat from burning.

Meat with crackling can be roasted in the roasting tin without the lid.

Turn the roast after 1/2 - 2/3 of the cooking time.

To keep meat more succulent:

- roast lean meat in the roasting tin with the lid or use roasting bag.
- roast meat and fish in large pieces (1 kg or more).
- baste large roasts and poultry with their juices several times during roasting.

10.24 Roasting

Beef

Food	Quantity (kg)	Function	Temperature (°C)	Time (min)
Braised meat	1 - 1.5	Conventional Cooking	230	120 - 150
Roast beef or fillet: rare	1 cm thick	Grill + Fan	190 - 200 ¹⁾	5 - 6

Food	Quantity (kg)	Function	Temperature (°C)	Time (min)
Roast beef or fillet: medium	1 cm thick	Grill + Fan	180 - 190 ¹⁾	6 - 8
Roast beef or fillet: well done	1 cm thick	Grill + Fan	170 - 180 ¹⁾	8 - 10

1) Preheat the oven.

Pork

Food	Quantity (kg)	Function	Temperature (°C)	Time (min)
Shoulder / Neck / Ham joint	1 - 1.5	Grill + Fan	150 - 170	90 - 120
Chop / Spare rib	1 - 1.5	Grill + Fan	170 - 190	30 - 60
Meatloaf	0.75 - 1	Grill + Fan	160 - 170	50 - 60
Pork knuckle (pre-cooked)	0.75 - 1	Grill + Fan	150 - 170	90 - 120

Veal

Food	Quantity (kg)	Function	Temperature (°C)	Time (min)
Roast veal	1	Grill + Fan	160 - 180	90 - 120
Knuckle of veal	1.5 - 2	Grill + Fan	160 - 180	120 - 150

Lamb

Food	Quantity (kg)	Function	Temperature (°C)	Time (min)
Leg of lamb / Roast lamb	1 - 1.5	Grill + Fan	150 - 170	100 - 120
Saddle of lamb	1 - 1.5	Grill + Fan	160 - 180	40 - 60

Game

Food	Quantity (kg)	Function	Temperature (°C)	Time (min)
Saddle / Leg of hare	1	Grill + Fan	180 - 200 ¹⁾	35 - 55
Saddle of venison	1.5 - 2	Conventional Cooking	180 - 200	60 - 90

Food	Quantity (kg)	Function	Temperature (°C)	Time (min)
Haunch of venison	1.5 - 2	Conventional Cooking	180 - 200	60 - 90

1) Preheat the oven.

Poultry

Food	Quantity (kg)	Function	Temperature (°C)	Time (min)
Poultry portions	0.2 - 0.25	Grill + Fan	200 - 220	30 - 50
Half chicken	0.4 - 0.5	Grill + Fan	190 - 210	40 - 50
Chicken, poultry	1 - 1.5	Grill + Fan	190 - 210	50 - 70
Duck	1.5 - 2	Grill + Fan	180 - 200	80 - 100
Goose	3.5 - 5	Grill + Fan	160 - 180	120 - 180
Turkey	2.5 - 3.5	Grill + Fan	160 - 180	120 - 150
Turkey	4 - 6	Grill + Fan	140 - 160	150 - 240

Fish

Food	Quantity (kg)	Function	Temperature (°C)	Time (min)
Whole fish	1 - 1.5	Grill + Fan	180 - 200	30 - 50

10.25 Grill

Preheat the empty oven for 5 minutes.

Put the pan to collect the fat into the first shelf position.

Grill

Food	Temperature (°C)	Time (min)		Shelf position
		1st side	2nd side	
Roast beef	210 - 230	30 - 40	30 - 40	2
Filet of beef	230	20 - 30	20 - 30	3
Back of pork	210 - 230	30 - 40	30 - 40	2
Back of veal	210 - 230	30 - 40	30 - 40	2
Back of lamb	210 - 230	25 - 35	20 - 25	3
Whole Fish, 0.5 - 1 kg	210 - 230	15 - 30	15 - 30	3 / 4

Fast Grilling

Preheat the empty oven for 3 minutes.

Grill with the maximum temperature setting.

Food	Time (min)		Shelf position
	1st side	2nd side	
Pork fillet	10 - 12	6 - 10	4
Sausages	10 - 12	6 - 8	4
Fillet / Veal steaks	7 - 10	6 - 8	4
Toast with topping	6 - 8	-	4

10.26 Bottom + Grill + Fan

Food	Temperature (°C)	Time (min)	Shelf position
Pizza, frozen	200 - 220	15 - 25	2
Pizza American, frozen	190 - 210	20 - 25	2
Pizza, chilled	210 - 230	13 - 25	2
Pizza Snacks, frozen	180 - 200	15 - 30	2
French Fries, thin	190 - 210	15 - 25	3
French Fries, thick	190 - 210	20 - 30	3
Wedges / Croquettes	190 - 210	20 - 40	3
Hash Browns	210 - 230	20 - 30	3
Lasagne / Cannelloni, fresh	170 - 190	35 - 45	2
Lasagne / Cannelloni, frozen	160 - 180	40 - 60	2
Oven baked cheese	170 - 190	20 - 30	3
Chicken Wings	180 - 200	40 - 50	2

Frozen ready meals

Food	Function	Temperature (°C)	Time (min)	Shelf position
Frozen pizza	Conventional Cooking	as per manufacturer's instructions	as per manufacturer's instructions	3
French fries ¹⁾ (300 - 600 g)	Conventional Cooking or Grill + Fan	200 - 220	as per manufacturer's instructions	3

Food	Function	Temperature (°C)	Time (min)	Shelf position
Baguettes	Conventional Cooking	as per manufacturer's instructions	as per manufacturer's instructions	3
Fruit flans	Conventional Cooking	as per manufacturer's instructions	as per manufacturer's instructions	3

1) Turn the French fries 2 or 3 times during cooking.

10.27 Slow Cooking

Use this function to prepare lean, tender pieces of meat and fish with core temperatures no more than 65 °C. This function is not applicable to such recipes as pot roast or fatty roast pork. You can use the core temperature sensor to guarantee that the meat has the correct core temperature (see the table for the core temperature sensor).

In the first 10 minutes you can set an oven temperature between 80 °C and 150 °C. The default is 90 °C. After the temperature is set, the oven continues to cook at 80 °C. Do not use this function for poultry.



Always cook without a lid when you use this function.

1. Sear the meat in a pan on the hob on a very high setting for 1 - 2 minutes on each side.
2. Put the meat together with the hot roasting pan in the oven and on the wire shelf.
3. Put the core temperature sensor into the meat.
4. Select the function: Slow Cooking and set the correct end core temperature.

Set the temperature to 120 °C.

Food	Time (min)	Shelf position
Roast beef, 1 - 1.5 kg	120 - 150	1

Food	Time (min)	Shelf position
Fillet of beef, 1 - 1.5 kg	90 - 150	3
Roast veal, 1 - 1.5 kg	120 - 150	1
Steaks, 0.2 - 0.3 kg	20 - 40	3

10.28 Preserving

Use only preserve jars of the same dimensions available on the market.

Do not use jars with twist-off and bayonet type lids or metal tins.

Use the first shelf from the bottom for this function.

Put no more than six one-litre preserve jars on the baking tray.

Fill the jars equally and close with a clamp.

The jars cannot touch each other.

Put approximately 1/2 litre of water into the baking tray to give sufficient moisture in the oven.

When the liquid in the jars starts to simmer (after approximately 35 - 60 minutes with one-litre jars), stop the oven or decrease the temperature to 100 °C (see the table).

Soft fruit

Food	Temperature (°C)	Cooking time until simmering (min)	Continue to cook at 100 °C (min)
Strawberries / Blueberries / Raspberries / Ripe gooseberries	160 - 170	35 - 45	-

Stone fruit

Food	Temperature (°C)	Cooking time until simmering (min)	Continue to cook at 100 °C (min)
Pears / Quinces / Plums	160 - 170	35 - 45	10 - 15

Vegetables

Food	Temperature (°C)	Cooking time until simmering (min)	Continue to cook at 100 °C (min)
Carrots ¹⁾	160 - 170	50 - 60	5 - 10
Cucumbers	160 - 170	50 - 60	-
Mixed pickles	160 - 170	50 - 60	5 - 10
Kohlrabi / Peas / Asparagus	160 - 170	50 - 60	15 - 20

¹⁾ Leave standing in the oven after it is deactivated.

10.29 Drying

the door and let it cool down for one night to complete the drying.

- Cover trays with grease proof paper or baking parchment.
- For a better result, stop the oven halfway through the drying time, open

Vegetables

Food	Temperature (°C)	Time (h)	Shelf position	
			1 position	2 positions
Beans	60 - 70	6 - 8	3	1 / 4
Peppers	60 - 70	5 - 6	3	1 / 4
Vegetables for sour	60 - 70	5 - 6	3	1 / 4
Mushrooms	50 - 60	6 - 8	3	1 / 4
Herbs	40 - 50	2 - 3	3	1 / 4

Fruit

Food	Temperature (°C)	Time (h)	Shelf position	
			1 position	2 positions
Plums	60 - 70	8 - 10	3	1 / 4
Apricots	60 - 70	8 - 10	3	1 / 4
Apple slices	60 - 70	6 - 8	3	1 / 4
Pears	60 - 70	6 - 9	3	1 / 4

10.30 Bread Baking

Preheating is not recommended.

Food	Temperature (°C)	Time (min)	Shelf position
White Bread	170 - 190	40 - 60	2
Baguette	200 - 220	35 - 45	2
Brioche	180 - 200	40 - 60	2
Ciabatta	200 - 220	35 - 45	2
Rye Bread	170 - 190	50 - 70	2
Dark Bread	170 - 190	50 - 70	2
All Grain bread	170 - 190	40 - 60	2
Bread rolls	190 - 210	20 - 35	2

10.31 Food Sensor table

Beef	Food core temperature (°C)		
	Rare	Medium	Well done
Roast beef	45	60	70
Sirloin	45	60	70

Beef	Food core temperature (°C)		
	Less	Medium	More
Meat loaf	80	83	86

Pork	Food core temperature (°C)		
	Less	Medium	More
Ham, Roast	80	84	88
Chop (saddle), Smoked pork loin, Smoked loin poached	75	78	82

Veal	Food core temperature (°C)		
	Less	Medium	More
Roast veal	75	80	85
Knuckle of veal	85	88	90

Mutton / lamb	Food core temperature (°C)		
	Less	Medium	More
Leg of mutton	80	85	88
Saddle of mutton	75	80	85
Leg of lamb, Roast lamb	65	70	75

Game	Food core temperature (°C)		
	Less	Medium	More
Saddle of hare, Saddle of venison	65	70	75
Leg of hare, Whole hare, Leg of venison	70	75	80

Poultry	Food core temperature (°C)		
	Less	Medium	More
Chicken (whole / half / breast)	80	83	86
Duck (whole / half), Turkey (whole / breast)	75	80	85
Duck (breast)	60	65	70

Fish (salmon, trout, zander)	Food core temperature (°C)		
	Less	Medium	More
Fish (whole / large / steamed), Fish (whole / large / roasted)	60	64	68
Casseroles - Precooked vegetables	Food core temperature (°C)		
	Less	Medium	More
Zucchini Casserole, Broccoli Casserole, Fennel Casserole	85	88	91
Casseroles - Savoury	Food core temperature (°C)		
	Less	Medium	More
Cannelloni, Lasagne, Pasta bake	85	88	91
Casseroles - Sweet	Food core temperature (°C)		
	Less	Medium	More
White bread casserole with / without fruits, Rice porridge casserole with / without fruits, Sweet noodle casserole	80	85	90

10.32 Information for test institutes

Tests according to EN 60350-1:2013 and IEC 60350-1:2011.

Baking on one level. Baking in tins

Food	Function	Temperature (°C)	Time (min)	Shelf position
Fatless sponge cake	True Fan Cooking	140 - 150	35 - 50	2
Fatless sponge cake	Top / Bottom Heat	160	35 - 50	2
Apple pie (2 tins Ø20 cm, diagonally off set)	True Fan Cooking	160	60 - 90	2
Apple pie (2 tins Ø20 cm, diagonally off set)	Top / Bottom Heat	180	70 - 90	1

Baking on one level. Biscuits

Food	Function	Temperature (°C)	Time (min)	Shelf position
Short bread / Pastry stripes	True Fan Cooking	140	25 - 40	3
Short bread / Pastry stripes	Top / Bottom Heat	160 ¹⁾	20 - 30	3
Small cakes (20 per tray)	True Fan Cooking	150 ¹⁾	20 - 35	3
Small cakes (20 per tray)	Top / Bottom Heat	170 ¹⁾	20 - 30	3

¹⁾ Preheat the oven.

Multilevel Baking. Biscuits

Food	Function	Temperature (°C)	Time (min)	Shelf position	
				2 positions	3 positions
Short bread / Pastry Stripes	True Fan Cooking	140	25 - 45	1 / 4	1 / 3 / 5
Small cakes (20 per tray)	True Fan Cooking	150 ¹⁾	23 - 40	1 / 4	-

¹⁾ Preheat the oven.

Grill

Preheat the empty oven for 5 minutes.

Food	Function	Temperature (°C)	Time (min)	Shelf position
Toast	Grill	max	1 - 3	5
Beef Steak	Grill	max	24 - 30 ¹⁾	4

¹⁾ Turn halfway through.

Fast Grilling

Preheat the empty oven for 3 minutes.

Grill with the maximum temperature setting.

Food	Time (min)		Shelf position
	1st side	2nd side	
Burgers	8 - 10	6 - 8	4
Toast	1 - 3	1 - 3	4

10.33 Information for test institutes

Tests according to IEC 60350-1.

Tests for the function: Full Steam.

Food	Container (Gastro-norm)	Quantity (g)	Shelf position	Temperature (°C)	Time (min)	Comments
Broccoli ¹⁾	1 x 2/3 perforated	300	3	99	13 - 15	Put the baking tray on the first shelf position.
Broccoli ¹⁾	2 x 2/3 perforated	2 x 300	2 and 4	99	13 - 15	Put the baking tray on the first shelf position.
Broccoli ¹⁾	1 x 2/3 perforated	max.	3	99	15 - 18	Put the baking tray on the first shelf position.
Frozen peas	2 x 2/3 perforated	2 x 1500	2 and 4	99	Until the temperature in the coldest spot reaches 85 °C.	Put the baking tray on the first shelf position.

¹⁾ Preheat the oven for 5 minutes.

11. CARE AND CLEANING



WARNING!
Refer to Safety chapters.

11.1 Notes on cleaning

Clean the front of the oven with a soft cloth with warm water and a mild cleaning agent.

To clean metal surfaces, use a dedicated cleaning agent.

To clean the bottom side in case of limestone residual, use some drops of vinegar.

Clean the oven interior after each use. Fat accumulation or other food remains may result in a fire. The risk is higher for the grill pan.

Clean all accessories after each use and let them dry. Use a soft cloth with warm water and a cleaning agent.

Clean stubborn dirt with a special oven cleaner.

If you have nonstick accessories, do not clean them using aggressive agents, sharp-edged objects or a dishwasher. It can cause damage to the nonstick coating.

Clean the moisture from the cavity after each use.

11.2 Recommended cleaning products

Do not use abrasive sponges or aggressive detergents. It can cause damage to the enamel and the stainless steel parts.

You can buy our products at www.aeg.com/shop and at the best retailer shops.

11.3 Removing the shelf supports

Before maintenance, make sure that the oven is cool. There is a risk of burns.

To clean the oven, remove the shelf supports.

1. Pull carefully the supports up and out of the front catch.

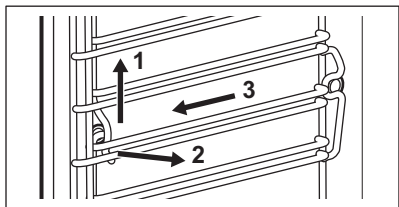

2. Pull the front end of the shelf support away from the side wall.
3. Pull the supports out of the rear catch.

Install the shelf supports in the opposite sequence.

11.4 Steam Cleaning

Remove as much dirt as possible manually.

Remove the accessories and the shelf support to clean the side walls.

The steam cleaning functions support the steam cavity cleaning of the oven.

Before you start a cleaning procedure, make sure that the oven is cool.

When the steam cleaning function works, the light is off.

1. Fill the water drawer to the maximum level.
2. Choose the steam cleaning function in the menu: Cleaning.

Steam Cleaning - the duration of the function is around 30 minutes.

- a) Turn on the function.
- b) When the programme ends a signal sounds.
- c) Press the rotary knob to turn off the signal.

Steam Cleaning Plus - the duration of the function is around 75 minutes.

- a) Spray a suitable detergent uniformly in the oven cavity on both enamel and steel parts.
- b) Turn on the function.
The first part of the programme ends after around 50 minutes.
- c) Wipe the cavity of the oven with a non-abrasive surface care sponge. You can use warm water or oven detergents.
- d) The final part of the procedure starts. The duration of this stage is around 25 minutes.

3. Wipe the cavity of the oven with a non-abrasive sponge. You can use warm water.

4. Remove the remaining water from the water drawer.

After cleaning keep the oven door open for approximately 1 hour. Wait until the oven is dry. To speed up the drying you can heat up the oven with hot air at temperature 150 °C for approximately 15 minutes. You can get maximum effects of the cleaning function if you manually clean the oven immediately after the function ends.

11.5 Cleaning Reminder

When reminder is displayed cleaning is necessary. Perform the function Steam Cleaning Plus.

11.6 Cleaning the water drawer

Remove the water drawer from the oven.

1. Remove the lid of the water drawer.
Lift the cover in correspondence with the protrusion in the rear.

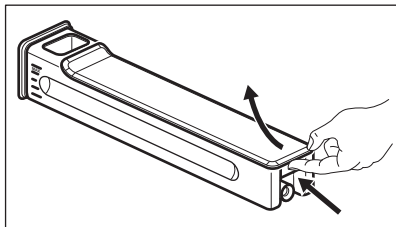

2. Remove the wave-breaker. Pull it away from the drawer body until it snaps out.
3. Wash the water drawer parts with your hands. Use tap water and soap. Do not use abrasive sponges. Do not put water drawer inside a dish washer.

After you clean the water drawer parts, reassemble the water drawer.

1. Snap in the wave-breaker. Push it into the drawer body.
2. Assemble the lid. First insert the front snap and then push it against the drawer body.

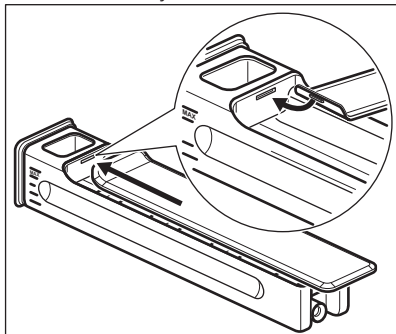

3. Insert the water drawer inside the appliance.
4. Push the water drawer towards the oven until it latches.

11.7 Steam generation system - Descaling

When the steam generator operates, limestone accumulates inside it (because of calcium contents in the water). This can have a negative effect on the steam quality, on the performance of the steam generator and on the food quality. To prevent limestone accumulation, clean the steam generation circuit.

Remove all accessories.

Select the function from the menu: Cleaning. The user interface will guide you through the procedure.

The duration of the complete procedure is about 2 hours.

The light in this function is off.

1. Put the grill- / roasting pan on the first shelf position.
2. Put 250 ml of the descaling agent in the water drawer.
3. Fill the remaining part of the water drawer with water to the maximum level.
4. Insert the water drawer.
5. Press the rotary knob.

This activates the first part of the procedure: Descaling.



The duration of this part is around 1 hour 40 minutes.

6. After the end of the first part, empty the grill- / roasting pan and put it on the first shelf position again.
7. Fill the water drawer with fresh water. Make sure there is no remaining cleaning solution inside the water drawer.
8. Insert the water drawer.
9. Press **START**.

This activates the second part of the procedure: Descaling. It will rinse the steam generation circuit.



The duration of this part is around 35 minutes.

Remove the grill- / roasting pan after the end of the procedure.



If the function: Descaling is not performed in the correct way, the display will show a message to repeat it.

If the oven is humid or wet, wipe it out with a dry cloth. Let the oven dry fully with the door open.

11.8 Descaling reminder

There are two descaling reminders which remind you to perform the function: Descaling.

The soft reminder reminds and recommends you to perform the descaling cycle.

The hard reminder obligates you to perform the descaling.



If you do not descale the appliance when the hard reminder is on, you cannot use the steam functions. You cannot disable the descaling reminder.

11.9 Steam generation system - Rinsing

Remove all accessories.

Select the function from the menu: Cleaning. The user interface will guide you through the procedure.

The duration of the function is around 30 minutes.

The light in this function is off.

1. Put the baking tray on the first shelf position.
2. Fill the water drawer with fresh water.
3. Press **START**.

Remove the baking tray after the end of the procedure.

11.10 Removing and installing the door

You can remove the door and the internal glass panels to clean it. The number of glass panels is different for different models.



WARNING!

The door is heavy.

1. Open the door fully.
2. Fully lift up the clamping levers (A) on the two door hinges.

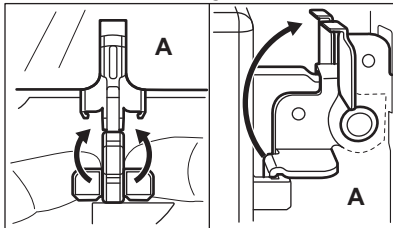

3. Close the door until it is at an angle of approximately 45°.

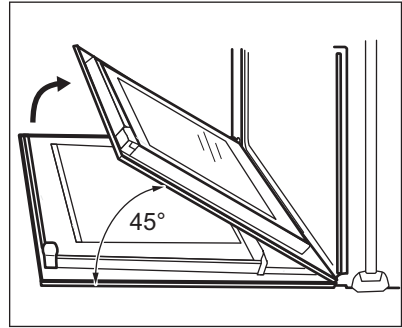

4. Hold the door with one hand on each side and pull it away from the oven at an upwards angle.
5. Put the door with the outer side down on a soft cloth on a stable surface.
6. Hold the door trim (B) on the top edge of the door at the two sides and push inwards to release the clip seal.

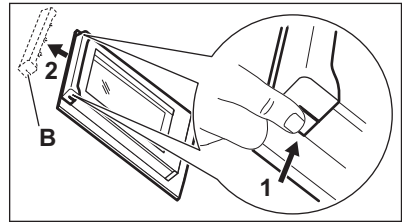

CAUTION!

Rough handling of the glass, especially around the edges of the front panel, can cause the glass to break.

7. Pull the door trim to the front to remove it.
8. Hold the door glass panels on their top edge one by one and pull them up out of the guide.

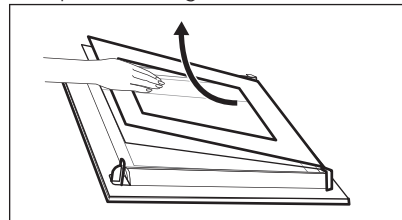

9. Clean the glass panel with water and soap. Dry the glass panel carefully.

When the cleaning is completed, do the above steps in the opposite sequence. Install the smaller panel first, then the larger and the door.



WARNING!

Make sure that the glasses are inserted in the correct position otherwise the surface of the door may overheat.

11.11 Replacing the lamp



WARNING!

Risk of electric shock.
The lamp can be hot.

1. Turn off the oven.
Wait until the oven is cooled down.
2. Disconnect the oven from the mains.
3. Put a cloth on the bottom of the cavity.

The top lamp

1. Turn the lamp glass cover to remove it.

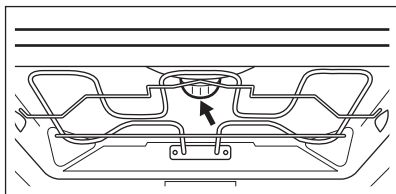

2. Remove the metal ring and clean the glass cover.
3. Replace the lamp with a suitable 300 °C heat-resistant lamp.
4. Attach the metal ring to the glass cover.
5. Install the glass cover.

The side lamp

1. Remove the left shelf support to get access to the lamp.
2. Use a Torx 20 screwdriver to remove the cover.
3. Remove and clean the metal frame and the seal.
4. Replace the lamp with a suitable 300 °C heat-resistant lamp.
5. Install the metal frame and the seal. Tighten the screws.
6. Install the left shelf support.

12. TROUBLESHOOTING



WARNING!

Refer to Safety chapters.

12.1 What to do if...

Problem	Possible cause	Remedy
You cannot activate or operate the oven.	The oven is not connected to an electrical supply or it is connected incorrectly.	Check if the oven is correctly connected to the electrical supply (refer to the connection diagram if available).
The oven does not heat up.	The oven is deactivated.	Activate the oven.
The oven does not heat up.	The clock is not set.	Set the clock.

Problem	Possible cause	Remedy
The oven does not heat up.	The necessary settings are not set.	Make sure that the settings are correct.
The oven does not heat up.	The automatic switch-off is activated.	Refer to "Automatic switch-off".
The oven does not heat up.	The door is not closed correctly.	Fully close the door.
The oven does not heat up.	The fuse is blown.	Make sure that the fuse is the cause of the malfunction. If the fuse is blown again and again, contact a qualified electrician.
The lamp does not operate.	The lamp is defective.	Replace the lamp.
The display prompts to set the Language.	There was a power cut longer than 3 days.	Refer to "Before first use" chapter.
The display prompts to set the Language.	The demo mode is activated.	Turn off demo mode in: Menu / Basic Settings / DEMO. Activation / deactivation code: 2468.
The display shows F111.	The plug of the core temperature sensor is not correctly installed into the socket.	Put the plug of the core temperature sensor as far as possible into the socket.
The display shows an error code that is not in this table.	There is an electrical fault.	<ul style="list-style-type: none"> Deactivate the oven with the house fuse or the safety switch in the fuse box and activate it again. If the display shows the error code again, contact the Customer Care Department.
Steam and condensation settle on the food and in the cavity of the oven.	You left the dish in the oven for too long.	Do not leave the dishes in the oven for longer than 15 - 20 minutes after the cooking process ends.
The appliance does not retain the water drawer after you insert it.	You did not assemble the lid of the water drawer correctly.	Assemble the lid of the water drawer correctly.
Water comes out of the water drawer after you carry it or put it inside the appliance.	You did not assemble the lid of the water drawer correctly.	Assemble the lid of the water drawer correctly.

Problem	Possible cause	Remedy
Water comes out of the water drawer after you carry it or put it inside the appliance.	You did not assemble the wave-breaker correctly.	Assemble the wave-breaker in the body of the water drawer correctly.
The appliance does not retain the water drawer after you push it on the cover.	You did not fully press the water drawer body.	Insert the water drawer body in the appliance by pushing it until it reaches to the end.
The water drawer is difficult to clean.	You did not remove the lid and the wave-breaker.	Refer to "Cleaning the water drawer".
The descaling procedure is interrupted before it finishes.	There was a power cut.	Repeat the procedure.
The descaling procedure is interrupted before it finishes.	The function was stopped by the user.	Repeat the procedure.
There is no water inside the grill- / roasting pan after the descaling procedure.	You did not fill the water drawer to the maximum level.	Check if the a descaling agent / water is present in the water drawer body. Repeat the procedure.
There is dirty water on the bottom of the cavity after the descaling cycle.	The grill- / roasting pan is on a wrong shelf position.	Remove the residual water and the descaling agent from the bottom of the oven. Put the grill- / roasting pan on the first shelf position.
The cleaning function is interrupted before it finishes.	There was a power cut.	Repeat the procedure.
The cleaning function is interrupted before it finishes.	The function was stopped by the user.	Repeat the procedure.
There is too much water on the bottom of the cavity after the end of the cleaning function.	You sprayed too much detergent in the appliance before the activation of the cleaning cycle.	Cover all parts of the cavity with a thin layer of the detergent. Spray the detergent evenly.
There is no good performance of the cleaning procedure.	The initial oven cavity temperature of the steam cleaning function was too high.	Repeat the cycle. Run the cycle when the appliance is cold.
There is no good performance of the cleaning procedure.	You did not remove the side grids before the start of the cleaning procedure. They can transfer heat to the walls and decrease the performance.	Remove the side grids from the appliance and repeat the function.

Problem	Possible cause	Remedy
There is no good performance of the cleaning procedure.	You did not remove the accessories from the appliance before the start of the cleaning procedure. They can compromise the steam cycle and decrease the performance.	Remove the accessories from the appliance and repeat the function.

12.2 Service data

If you cannot find a solution to the problem yourself, contact your dealer or an Authorised Service Centre.

The necessary data for the service centre is on the rating plate. The rating plate is

on the front frame of the oven cavity. Do not remove the rating plate from the oven cavity.

We recommend that you write the data here:	
Model (MOD.)
Product number (PNC)
Serial number (S.N.)

13. ENERGY EFFICIENCY

13.1 Product Fiche and information according to EU 65-66/2014

Supplier's name	AEG
Model identification	BSK892230B
Energy Efficiency Index	61.9
Energy efficiency class	A++
Energy consumption with a standard load, conventional mode	0.89 kWh/cycle
Energy consumption with a standard load, fan-forced mode	0.52 kWh/cycle
Number of cavities	1
Heat source	Electricity
Volume	70 l
Type of oven	Built-In Oven
Mass	39.0 kg

EN 60350-1 - Household electric cooking appliances - Part 1: Ranges, ovens, steam ovens and grills - Methods for measuring performance.

13.2 Energy saving



The oven contains features which help you save energy during everyday cooking.

General hints

Make sure that the oven door is closed properly when the oven operates. Do not open the door too often during cooking. Keep the door gasket clean and make sure it is well fixed in its position.

Use metal dishes to improve energy saving.

When possible, do not preheat the oven before you put the food inside.

When the cooking duration is longer than 30 minutes, reduce the oven temperature to minimum 3 - 10 minutes before the end of the cooking time, depending on the duration of the cooking. The residual heat inside the oven will continue to cook.

Use the residual heat to warm up other dishes.

Keep breaks between baking as short as possible when you prepare few dishes at one time.

Cooking with fan

When possible, use the cooking functions with fan to save energy.

Residual heat

If a programme with the Duration or End Time selection is activated and the cooking time is longer than 30 minutes, the heating elements automatically deactivate earlier in some oven functions.

The fan and lamp continue to operate.

Keep food warm

Choose the lowest possible temperature setting to use residual heat and keep a meal warm. The residual heat indicator or temperature appears on the display.

Cooking with the lamp off

Turn off the lamp during cooking. Turn it on only when you need it.

Moist Fan Baking

Function designed to save energy during cooking.

When you use Moist Fan Baking, the lamp automatically turns off after 30 seconds. You may turn on the lamp again but this action will reduce the expected energy savings.

14. ENVIRONMENTAL CONCERNS

Recycle materials with the symbol . Put the packaging in relevant containers to recycle it. Help protect the environment and human health by recycling waste of electrical and electronic appliances. Do not dispose of

appliances marked with the symbol  with the household waste. Return the product to your local recycling facility or contact your municipal office.

www.aeg.com/shop



867344349-B-462018



AEG